

# A Framework for Load Shedding and Demand Response in DC Microgrid using Multi Agent System

Diana Rwegasira<sup>1,2</sup>, Imed Ben Dhaou<sup>3,6</sup>, Anastasia Anagnostou<sup>4</sup>, Aron Kondoro<sup>1,2</sup>, Naiman Shililiandumi<sup>2</sup>, Amleset Kelati<sup>1,5</sup>, Simon JE Taylor<sup>4</sup>, Nerey Mvungi<sup>2</sup>, Hannu Tenhunen<sup>1,5</sup>.

<sup>1</sup> KTH Royal Institute of Technology in Stockholm (SWEDEN)

<sup>2</sup> University of Dar es Salaam (TANZANIA)

<sup>3</sup> College of Engineering, Qassim University (SAUDI ARABIA)

<sup>4</sup> Brunel University (UK)

<sup>5</sup> University of Turku (FINLAND)

<sup>6</sup> University of Monastir (TUNISIA)

dianasr@kth.se, phd.imed.bendhaou@ieee.org, anastasia.anagnostou@brunel.ac.uk, kondoro@kth.se, smakere@gmail.com, smleset@kth.se, simon.taylor@brunel.ac.uk, nhmvungi@udsm.ac.tz, hannu@kth.se

**Abstract**—This paper presents a framework of load shedding experiment for a DC Microgrid using Multi-Agent System (MAS). The microgrid uses solar panels as source of energy to serve a community without access to electricity. The generated framework includes modelling of solar panels, battery storage and loads for effective control and better operation. The loads are classified as critical and non-critical loads. The agents are designed in a decentralized manner which include solar agent, storage agent and load agent. The load shedding experiment of the framework is mapped with the manual operation done at Kisiju village, Pwani, Tanzania. The results of the experiment focus on using accurate solar and PV panels which provide: (i) the multi agent system that runs in the DC microgrid, (ii) the controlling and monitoring of power to be used for critical and non-critical loads and (iii) the management power in the production process through selling extra power from an individual load to the storage.

## I. INTRODUCTION

To achieve the growth of the countries' economy, a safe and reliable technology in the provision of smart electricity is one of the factors which have to be considered. Smart grid is one of the latest technologies in the provision of automatic electric network from generation to the end users. It includes features such as self-healing, fault tolerance and detections, demand side managements and automatic load shedding. According to [1], the smart grid is an electricity network that can intelligently and smartly integrate the actions and users connected to it (generators, consumers, transmitters, distributors and those that do both) so as to efficiently deliver sustainable, economic and secure electricity supplies. Many countries have seen and started to benefit from smart grid and applications from the grid infrastructure, healthy and agricultural sectors as well as distributed supercomputing.

In developing countries, smart grid has not yet much implemented especially to control and monitor customer's side. The Tanzania Electric Supply Company (TANESCO) which is the sole supplier company of the electricity in Tanzania, the transmission side is the part which has been implemented in the

process of monitoring and controlling with smart grid and lesser extent to the primary distribution side of the grid system. There is still a need for the automation process in the control of electric power so as to increase efficiency in all aspects of the electric power system, optimize cost to consumers and reduce human power and errors. Also, the use of renewable energies such as solar and the wind are more valuable in the utilization and provision of electricity in places without access to the national grid. When the smart network system has been integrated with renewable energies as a source of power, this is referred to as *smart microgrid*. According to [2], microgrid system are capable of rapidly detecting, controlling, managing, analyzing and responding to various perturbations in the network by integrating advanced control methods such as agent based systems.

The control and management of distributed energy systems using multi agent systems in smart grid have been seen to work effectively in the provision of autonomous actions. According to [3], "An agent is a computer system or device that is situated in some environment and is capable of taking autonomous action in this environment in order to meet its design objectives". The system which has more than one agent working together is referred to as multi agent system. The study by [4] discussed that, agent based system can be applied in the management of distributed energy systems including demand side management, storage and generation. Other sectors by which multi agent systems can be applied are e-health, transportations and infrastructure.

This work uses accurate solar and PV models to show the impact on the control and monitoring of dynamic loads power consumption compared to static loads discussed in [5]. Also, the demand response with respect to power is discussed where by an individual load can provide extra power to the main storage for continuous production. Our paper is structured as follows: Section II describes related work. Problem Statement will be described in Section III. The methodology of our experiment will be elaborated in Section IV. Section V will be discuss the simulation results. Finally, Section VI concludes our paper.

## II. RELATED WORK

The rapid increase of the load consumption or the decrease of power generation may cause the instability of line frequency and voltage, and this may lead to unwanted overloading which in turn disturb the power system stability. It is generally recommended that the best way to overcome the problems is the load shedding to temporally eliminate some loads out of the system. Working with load shedding requires different strategies based on optimization and demand response. The prioritization of loads in the microgrid system is important in order that the critical loads continue to have access of power. The research done by [6] focus on load shedding for an islanded microgrid with limited generation of the resources. The model proposed an optimal load shedding which was formulated using Markov decision process (MDP).

Demand side management is a factor which goes in parallel in the provision of constant and efficient power to the end users. The importance of demand response in consumer side has been addressed in [7] to describe how it can be in cooperated with the grid for maximum production of the electricity. It involves reducing electricity use through activities or programs that promote electric energy efficiency or conservation, or more efficient management of electric energy loads.[8] Described on how demand response can have a greater impact in the society with respect to energy usage and utilization.

Modeling of multi agent systems has become popular in many industrial and residential sectors. Many results which have been obtained based on the application of multi agent systems have seen to work successfully. [9] Presented the multi agent for real operation in a microgrid. The mainly focus was on central scheduling and demand side management. The model formulated based on the power generated and those consumed by the battery as well as the loads. In the modeling of DC microgrid, three main areas of concentration are generation part (source of power), storage part (battery) and the consumption part (loads). In modeling of the source of power, the main characteristics are the I-V and P-V behaviors. For storage modeling, the focus is on charging and discharging behaviors while on consumer side, the most case scenario depends on random generation of power and demand side management. In this research, the modeling focus on solar and PV panels' characteristics with respect to sun irradiations, battery storage with respect to State of Charge (SoC) while on load the focus is on uniform distribution with respect to time t.

## III. PROBLEM STATEMENT

Electricity demand in Tanzania is increasing rapidly due to the accelerated productive investments and the need of basic needs such as health, communication and education. According to[10], 14% of the population in Tanzania has access to electricity in rural areas. This percentage is small compared to the number of people in the country. Renewable Energy Agency (REA) and solar companies such as Helvetic solar, TAREA, and Ensol have invested on providing solar technologies in Tanzania to solve electric problems. The main concern remained on the individual/household to manage the cost of investing on solar. In villages, people still use wood, charcoal and candles for cooking and lightening purposes. The government has also considered only TANESCO to supply the

electricity to the country where the budget is low and the demand at villages is still high.

Control and monitoring processes in the electric field are fundamental aspects to facilitate the smart microgrid network. To master these attributes, different systems and mechanisms are required in handling activities from transmission to end user side of the electrical network. In Tanzania, the link between the transmissions, distribution and end users side based on smart grid system has not yet implemented. TANESCO is facing several challenges which can be grouped into systems challenges and natural challenges. Natural challenges refer to the problem of aging infrastructure and the growth of electric demand while system challenges refer to poor management and fast responses of any failure of the systems.

The concept of using decentralized microgrid in the community needs emphasis on proper management, controlling and monitoring aspects for effective facilitation of activities such as self-healing of the systems, fault detection and tolerance, automatic load shedding as well as sharing of power in case consumers have extra power capacity. There is no decentralized system using agent based distributed network to offer smart solutions to the network. Problems such as automatic load shedding, fault detection and tolerance and self-healing to the system still exist in the community. Another attribute such as on demand response with pricing from individual houses/load to sell to the main sources has not yet been addressed using agents for provision of maximum power production in community and country at large. There is no clear study made in management and control of microgrid network systems using autonomous agents, to ensure secure and reliable systems.

## IV. METHODOLOGY

### A: DC Microgrid-Kisiju Pwani Model

The need of modelling of any system is very important for the success and predictions of the results. The work by [10], focus on the production of power though photovoltaic panels. This section explains how we model our solar, battery and loads in order to achieve load shedding and demand response based on power.

- Solar modelling

The means of converting the solar energy into a usable amount of direct current (DC) electricity can be done through the absorption of sunlight into the solar panels. Modelling of the solar panels is a common solution when describing different characteristics and behavior of solar. These characteristic of the solar panels are normally based on the voltage, illuminations and temperate of the surroundings.

To compute the altitude and azimuth angles, (1) and (2) were used.

$$\alpha = a \sin^{-1} \left\{ \sin \left( L * \frac{Pi}{180} \right) \times \sin \left( \delta * \frac{Pi}{180} \right) + \cos \left( \delta * \frac{Pi}{180} \right) \cos \left( L * \frac{Pi}{180} \right) \cos \left( \omega * \frac{Pi}{180} \right) \right\} \quad (1)$$

$$\theta = \sin^{-1} \left\{ \frac{\cos(\delta * \frac{Pi}{180}) \sin(\omega * \frac{Pi}{180})}{\cos(\alpha * \frac{Pi}{180})} \right\} \quad (2)$$

Where  $a$  is the apparent solar time,  $L$  the latitude in degree,  $\delta$  the declination angle, and  $\omega$  the hour angle.

To compute the total solar irradiation of the sun, (3) was also used:

$$S_{irr} = (1 + C) A e^{\{-k / \sin \alpha * \frac{Pi}{180}\}} \quad (3)$$

Where  $A$ ,  $C$  and  $k$  are factors which depends on the number of solar cells calculated as:

$$A = 1160 + \{75 \sin^{-1}\{(360/365) \times (N - 275)\}\} \quad (4)$$

$$k = 0.174 + \{0.035 \sin^{-1}\{(360/365) \times (N - 100)\}\} \quad (5)$$

$$C = 0.095 + \{0.04 \sin^{-1}\{(360/365) \times (N - 275)\}\} \quad (6)$$

The calculation of the PV model was based on several constant values as tabulated in Table I which lead to have (7)

TABLE I. SOLAR CELL PARAMETERS

Parameter	Constant value
Number of Suns, G	1000W/m <sup>2</sup>
Temp, T	273
Boltzmann's const, K	1.38e-23
Charge on an electron, q	1.60e-19
Diode quality, A	1.2
Band gap voltage, Vg	1.12
Open cct voltage per cell a temperature T1(25), Voc_T1	32.9V
Short cct current per cell at temp T1, Isc_T1	8.21
Open cct voltage per cell at temperature T2(75), Voc_T2	29.9
Short cct current per cell at temp T2(75), Isc_T2	6.62
king temp, TaK	TaK = 273 + TaC
reference temp, TrK	TrK = 273 + 25

$$I_{an} = I_{scT1} * Suns * (1 + a * (TaK - T1)) - Ir * \left( \exp\left(\frac{Vc + IaRs}{VtTa}\right) - 1 \right) \quad (7)$$

Where by

$$VtTa = A * kt/q \quad (8)$$

$$Ir = Ir_{T1} * \left(\frac{TaK}{T1}\right)^{\frac{1}{3/A}} * e^{\left(-b * \left(\frac{1}{TaK} - \frac{1}{T1}\right)\right)} \quad (9)$$

$$b = Vg * q / (A * k) \quad (10)$$

$$Ir_{T1} = \frac{I_{scT1}}{\left(\exp\left(\frac{V_{ocT1}}{A * Vt_{T1}}\right) - 1\right)} \quad (11)$$

- Storage modelling

The charging and discharging of the battery has been calculated using equation 5

$$C(t) = C(t - 1) + \left\{ \frac{\Delta t * \eta_b(t)}{V_b(t)} * P_{rew}(t) - P_u(t) \right\} \quad (12)$$

Where:  $P_u(t)$  is the renewable battery power,

$P_{rew}(t)$  is the total renewable power

$V_b(t)$  is the voltage of the battery terminals at time t

$\eta_b(t)$  is the Battery efficiency

$C(t)$  and  $C(t - 1)$  is the Battery charges at time t and t-1 respectively

- Load modeling

With modeling of the load, the main attribute is to generate the random values at given number of interval. Equation 6 was used which based on the uniform distribution with specified number of values needed.

$$r = Ai + (Ai + Bi) * rand(N, 1) \quad (13)$$

Where A, B = intervals of the random numbers to be generated

N = random generated numbers

i = the ith number generated

### B: Agent collaborations

There are three agents in our microgrid which are solar, storage and load. The load agents have their own solar and storage which have similar characteristics like the main solar except that it can perform load shedding. Fig. 1 shows the setup of the agents and their interconnection between each other. Table II also summarizes the functions of each agent implemented in the REPAST.

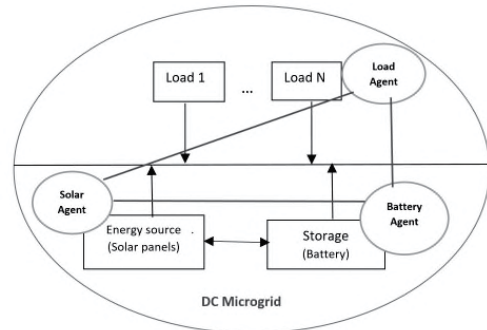

(10) • Fig. 1. Agent collaborations in DC Microgrid

- Solar agent

This is the main power supply to the battery and loads. The behavior of this agent is to obtain the solar radiation from the sunshine and generate the power from it. The higher the sunshine results to the maximum power production. The expected maximum power will be generated at 1200hours noon where the sunshine is the highest peak. The solar agent learn the behavior of the environments through sun radiations and illuminations, then produce an output of power. That action is autonomous and it changes according to the sunshine of the day. This agent is also responsible for charging the main battery up to the maximum level (80% of the SoC) and then supply the loads.

The distribution of power depends on the number of loads and their consumption of power per daily basis. The main solar is accountable for categorizing the critical and non-critical loads and to perform load shedding when the power is not sufficient. Also, the demand response of the solar agent is focusing on how the loads are able to provide extra power to the main storage for continuous distribution of power.

- Storage agent

The main task of this agent is the storage concept and act as a backup of the solar agent. It monitors the charging and discharging activities and ensures constant provision of power to the critical loads. This agent provides power when the solar do not have sufficient power to support the loads. Extra power is also shared to this agent to make demand response scheme based on pricing effective and efficient.

- Load agent

This agent has its own solar and storage for power usage where it can use it as per demand. The power consumption of each load is generated randomly per hours using (13). The load agent provides automatically extra power to the main source and respond to its own power when load shedding takes place.

TABLE II. FUNCTIONS OF EACH AGENTS

Method at time t	Agent		
	Solar	Battery	Load
	Solar irradiation and illumination of the sun	Charging and discharge	Random values generated in Kwh
	Current production for 24V to 48V dc.		Get excess power method
	Run: for running simulation		Run: for running simulation
Distribute power method	Distribute power method		

V. RESULTS AND DISCUSSION

The simulation of the results is based on the REPASt simulation tool which runs in Java. The results are demonstrated with 6 houses which are critical and non-critical loads. The simulation has been run with 100 tick counts which is equivalent to 100 hours. The working voltage is between 24V to 48V dc. There are two types of results: (i) Without load shedding and (ii) With load shedding and then discussion on their performances.

A. Without load shedding

The generation of power depends much on the solar radiations hit the panels. Fig.2 shows the behavior of power generated from sunrise to sunset. The maximum peak power generated is when there is a maximum sunshine.

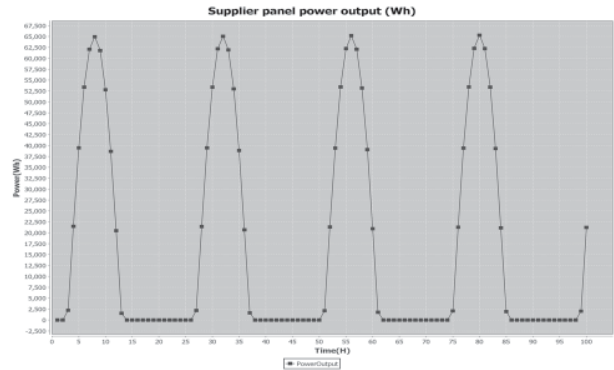

Fig. 2. Solar panel power against time

The current behavior of the solar panels is also the same that of power since power is directly proportional to the current. Fig.3 shows how current generated with respect to the voltage in the solar cells. The characteristics of the battery is also seen in Fig.4 where the battery discharges up to the defined SoC of 30%. The random generated power consumption if each load can be seen in Fig. 5 where the critical load is the one with maximum power consumption compared to the others. The variations of the maximum power can be varied depend on the microgrid requirements.

The total power generated through demand response of each load to provide extra load to the source has been summed up in Fig.6 for continuous production. Depending on the demand of the individual load, there is a time when the power generated is higher than the required hence, sell to the storage agent. Using the solar panels and sun radiations the power consumptions remained the same but provide the dynamicity of the load upon generated. In this case, changing of load behavior through increasing power consumption will results into more load shedding and hence stability of the microgrid.

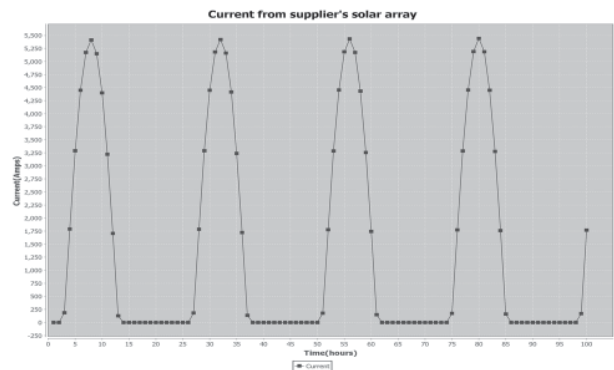

Fig. 3. Solar panel current against time



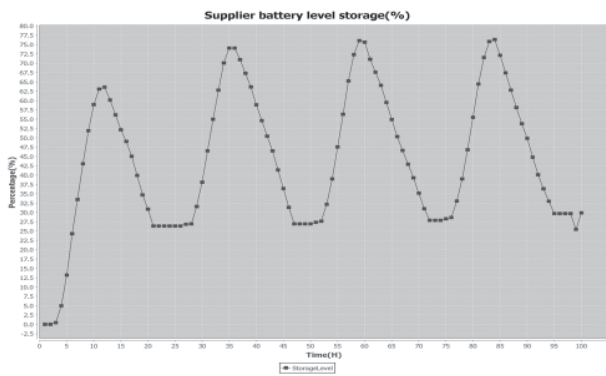

Fig. 4. Behavior of the battery on charging and discharging

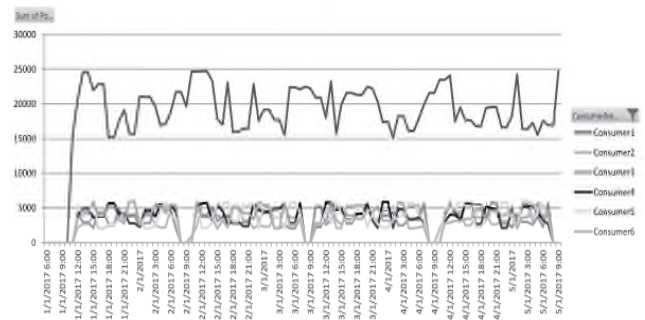

Fig. 7. Load shedding of critical load

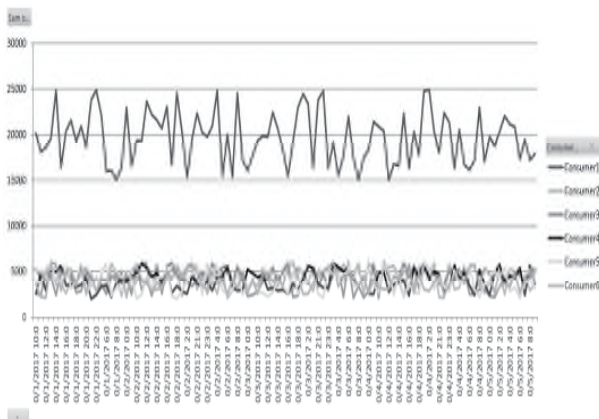

Fig. 5. Individual power consumption

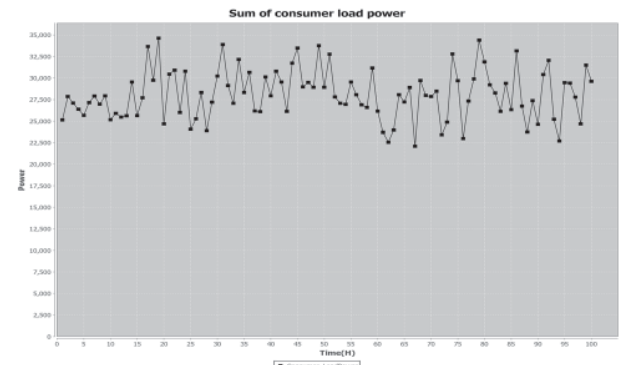

Fig. 6. Power supplied and generated

*B. With load shedding*

With respect to the number of houses simulated, the process of power generation in the solar and the battery capacity remain the same as it depends on solar radiation and PV panels. The effect of load shedding can be due to different cases such as increasing power consumption of the loads, power generation decreases or the battery capacity is minimal to save all the loads. Fig. 7 how load shedding has taken place leaving the critical load an affected while Fig.8 shows the extra power which have been given from different individual loads.

VI. CONCLUSION

The design and implementation of microgrid systems depends much on the perfect modelling of its components. This work shows the effect of both load shedding and no load shedding on modelling of the solar driven DC in microgrid. The results shows that, using random generated values of loads provides the intelligence of the agent to adjust and act accordingly based on the environment. With different numbers of houses, using multi agent system, the solar agent can manage to provide power to the microgrid and leave the critical load in a safe mode. Also, the effect of demand response can be achieve with load agents to provide extra power to the source automatically. The generation of power to save to the power sources is also valid if and only if the majority of the individual load do not have much power consumption. This will lead to the microgrid to sustain its generation and hence make demand per response.

ACKNOWLEDGEMENT

This work is supported by the Swedish government through the SIDA project. Much thanks also go to Dr.Omar Ali of Ardhi University for his support on formulation of the mathematical modelling in the microgrid.

REFERENCES

[1] A. Zaballos, A. Vallejo, and J. M. Selga, "Heterogeneous communication architecture for the smart grid," *IEEE Netw.*, vol. 25, no. 5, pp. 30–37, 2011.

- [2] S. Kihwele and A. L. Kyaruzi, "Effect of Poor Designing of Distribution System Case Study Tanzania Electric Supply Company Network," in *2004 International Conference on Power System TEchnology- POWERCON*, 2004, no. November, pp. 1298–1302.
- [3] F. Davoodi Samirmi, W. H. Tang, and Q. H. Wu, "Implementation of Gaia methodology for multi-agent based transformer condition monitoring," in *IEEE PES Innovative Smart Grid Technologies Conference Europe*, 2012, pp. 1–8.
- [4] Z. Jiang, "Agent-Based Control Framework for Distributed Energy Resources Microgrids," in *2006 IEEE/WIC/ACM International Conference on Intelligent Agent Technology*, 2006, pp. 646–652.
- [5] D. Rwegasira, I. Ben Dhaou, A. Kondoro, N. Shililiandumi, A. Kelati, and N. Mvungi, "A Multi-Agent System for Solar Driven DC Microgrid," in *ICCEREC*, 2017, pp. 1–6.
- [6] Y. Xu, C.-C. Liu, Y. Chen, and H. Gao, "Dynamic load shedding for an islanded microgrid with limited generation resources," *IET Gener. Transm. Distrib.*, vol. 10, no. 12, pp. 2953–2961, 2016.
- [7] B. Ciara, D. The, M. Engineering, P. Supervisor, and R. Duignan, "Modelling Demand Response in the Residential Sector," University College Dublin, 2011.
- [8] S. Saini, "Demand-side management module," in *Sustainable Energy Regulation and Policymaking for Africa*, 2007, pp. 1–100.
- [9] T. Logenthiran, D. Srinivasan, A. M. Khambadkone, and H. N. Aung, "Multiagent system for real-time operation of a microgrid in real-time digital simulator," *IEEE Trans. Smart Grid*, vol. 3, no. 2, pp. 925–933, 2012.
- [10] B. M. M. Mwinyiwiwa, R. T. Kivaisi, and C. Msoka, "Photovoltaic based Mini-Grid for Electrification of Remote Areas of Tanzania : The case of Kisiju-Pwani Village," Dar es Salaam, Tanzania, 2013.